



FASERFIX[®]KS+

with monolithic pre-cast reinforced concrete
channel body

EDITION 004-01.18EN



FASERFIX®KS+

CONCRETE CHANNEL WITH MONOLITHIC PRE-CAST REINFORCED CONCRETE CHANNEL BODY READY TO BE INSTALLED

FASERFIX®KS+ system is a linear drainage, that doesn't require preparing a base on the construction site.

This solution saves money and time.

High quality concrete C50/60 guarantees stability and durability.

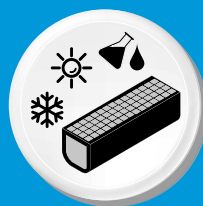
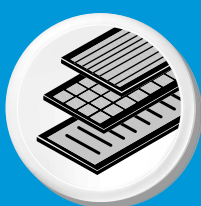

A PRODUCT, THAT IS A SYNONYM TO OPPORTUNITIES

FASERFIX®KS+ means:

- ✓ time and money saving,
- ✓ stable and durable material,
- ✓ numerous grating options,
- ✓ possible colouring of pre-cast reinforced concrete channel body,
- ✓ adjustment of pre-cast reinforced concrete channel body's parameters depending of investments requirements,
- ✓ possible surface texturing of the pre-cast reinforced concrete channel body.



GRATING PROTECTIONS

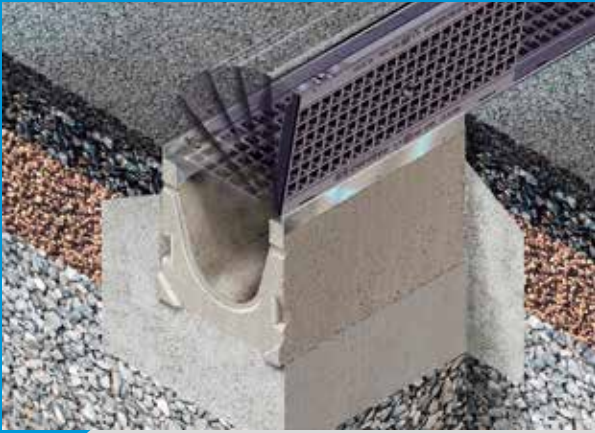

BOLTLESS LOCKING SYSTEM SIDE-LOCK®

SIDE LOCK® is a unique locking system, that allows replacement and insert of the grating without any special tool. Simply put the grating on the channel and press with your foot. When you hear the „click“ sound it means that the grating is safely installed and can be overdriven straight away. For maintenance you can deinstall the grating by use of a simple tool e.g. screwdriver. SIDE-LOCK® saves 90% of time of fixing the grating comparing to other locking systems. SIDE-LOCK® was constructed by HAURATON and is a patented solution.

VANDALPROOF BLOCKADE

In addition to the SIDE-LOCK® locking, the FASERFIX®KS system is equipped with additional protection in the form of anti-vandal interlock. For each half meter of grate, there is 1 blockade that prevents the grid from being removed or broken. This type of security is used in places where there is a high risk of theft of grates or on sports facilities such as stadiums.



KTL COATING

The KTL coating meets the highest quality requirements when it comes to corrosion protection. It is a uniform, thin coating that penetrates very deeply into the structure of cast iron. The coat is exceptionally resistant to motor fuels, acids and alkalis. It does not chip. Gratings covered with KTL coating are especially recommended in areas with an increased risk of aggressive substances presence, as well as in prestigious places with high aesthetic requirements, e. g. at glass elevations of buildings, where there is no natural abrasion of the iron oxide coating during the normal operation of traditional cast iron grates.

SPECIAL SOLUTIONS

There are several special solutions available for the **FASERFIX®KS+** system, such as colouring or surface texturing of the pre-cast reinforced concrete channel body or manufacturing the pre-cast reinforced concrete channel body with special parameters in order to meet investments requirements.

CHOSEN OPTIONS FOR SURFACE TEXTURING AND COLOUR OF PRE-CAST REINFORCED CONCRETE CHANNEL BODY

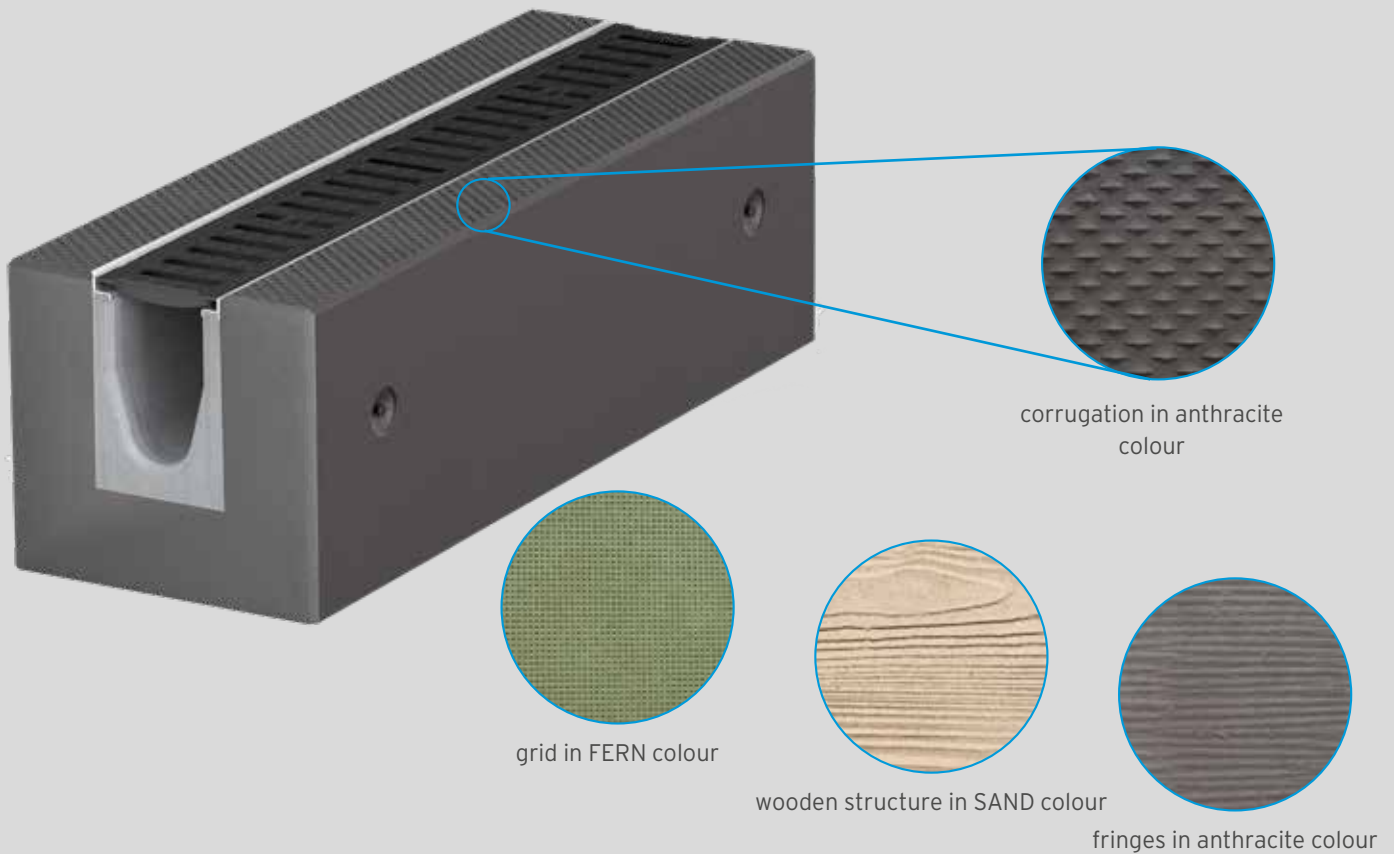

LOWERED PRE-CAST REINFORCED CONCRETE CHANNEL BODY

gives additional esthetique effect e.g. together with a cobblestone



SHALLOW CHANNELS WITH PRE-CAST REINFORCED CONCRETE CHANNEL BODY

for installation in e.g. underground park entries



COLOURED FIBRETEC® GRATINGS

Inspiration for the new gratings was the proven black FIBRETEC which has received various awards since its introduction in 2010. One of these awards is the International Design Award Baden-Württemberg Focus Open.

The production of the coloured FIBRETEC gratings in the colours Fern, Sand and Stone is done with coloured granulate. The result are uniformly coloured gratings which are particularly weather and UV-resistant.

This was tested and approved in the laboratory according to DIN EN ISO 4892-2 as required by DIN 19580: The gratings were exposed to artificial weathering for a total of 1,600 hours in the form of xenon arc radiation and irrigation.

The subsequent mechanical tests were very successful - optical changes were hardly measurable. However, slight long-term colour changes in the material cannot be ruled out.

FIBRETEC® Fern

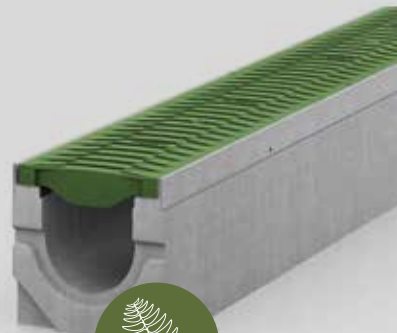

FIBRETEC® Sand



FIBRETEC® Stone

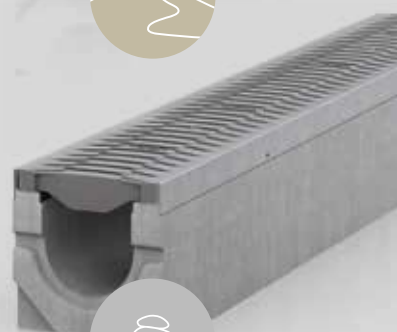

FIBRETEC® Black

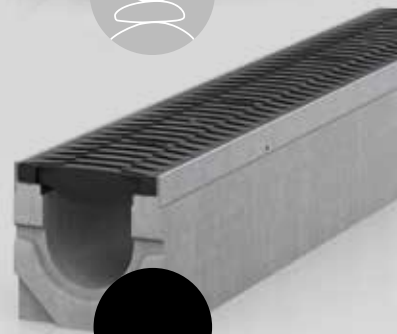

NUMEROUS GRATING OPTIONS

Ductile iron gratings, slotted



14 mm slot

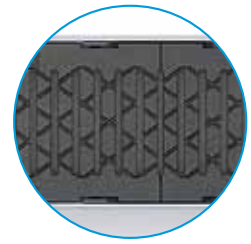

6 mm slot

Solid ductile iron covers

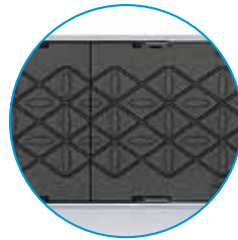

for KS+100

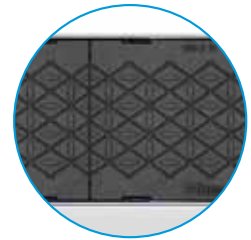

for KS+150

GUGI-Ductile iron mesh gratings

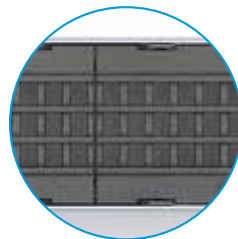

black

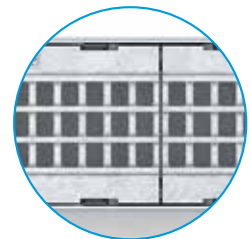

galvanised

Longitudinal ductile iron grating, KTL

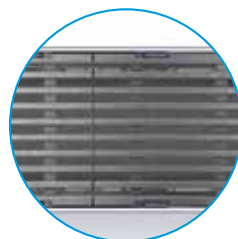

KTL coated



galvanised

G-TEC Ductile iron grating

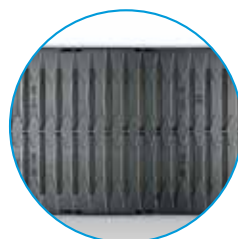

ductile iron

Ductile iron design grating METROPOLIS



ductile iron

Mesh grating, galvanised

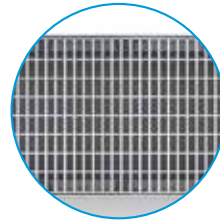
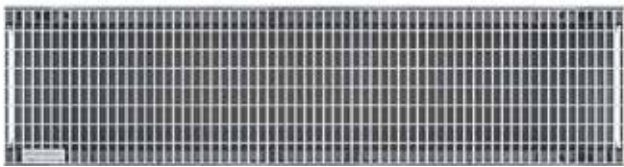

Mesh width:
11 x 30 mm

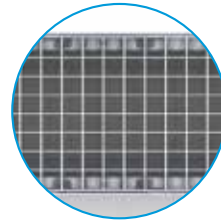

Mesh width:
30 x 30 mm

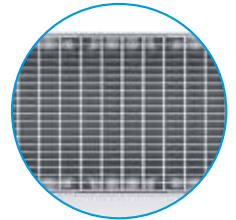

Mesh width:
30 x 10 mm

Slotted gratings



galvanised



stainless steel

Perforated gratings

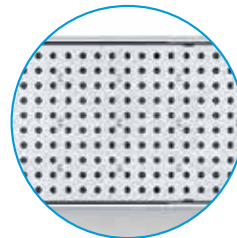

galvanised

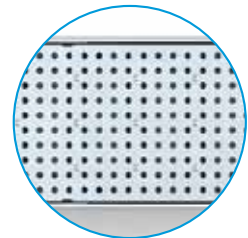

stainless steel

Longitudinal slot gratings, stainless steel

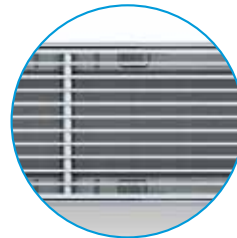

longitudinal

FIBRETEC® slotted grating, composite material

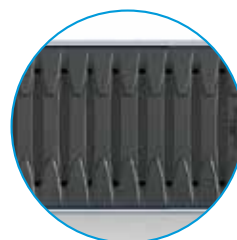

refined polyamide



SAND

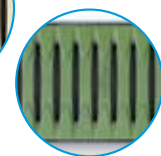

FERN



STONE

GUGI-Mesh grating, composite material



polyamide with fiber

METROPOLIS

Inspired from history - Made for the future

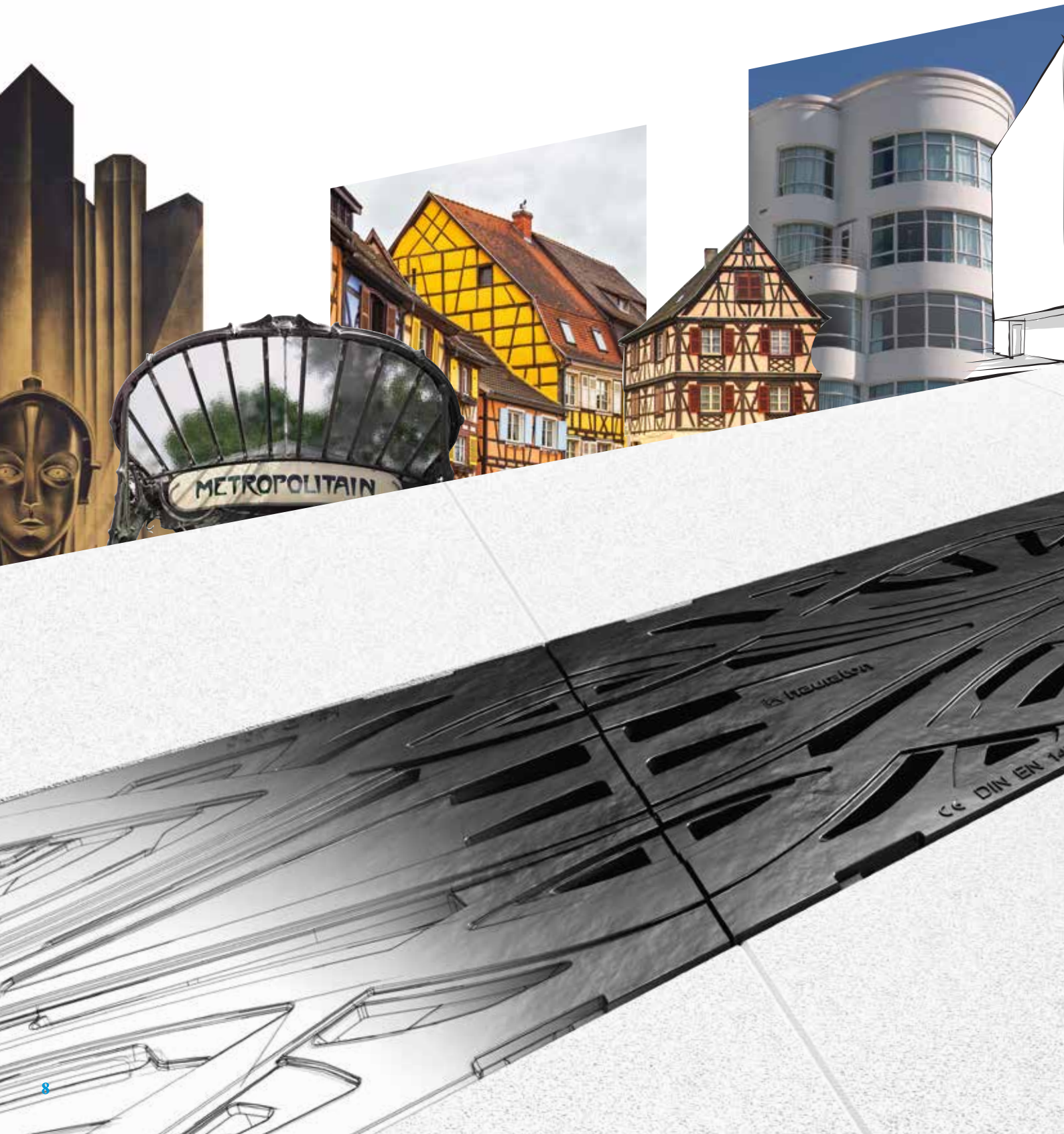

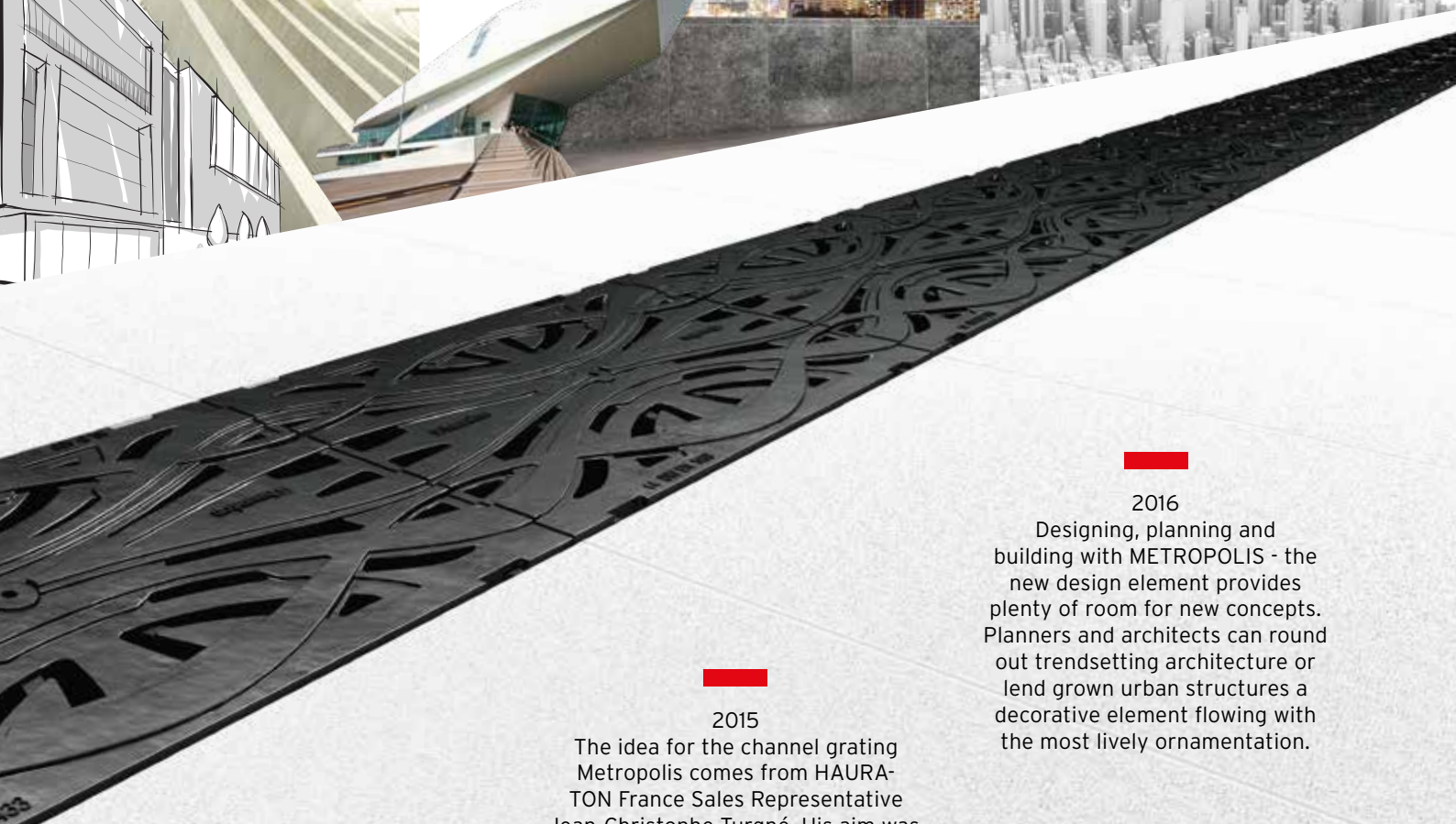
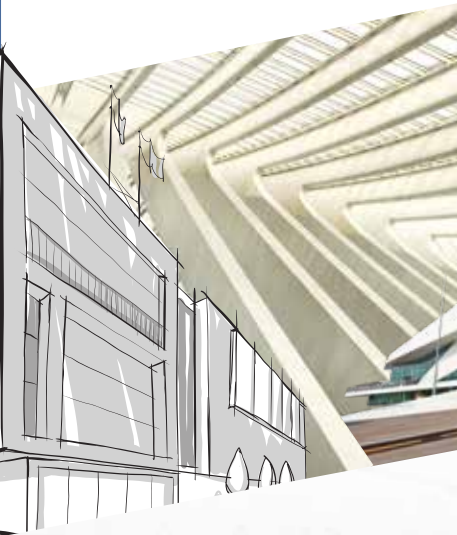

1927

The movie 'Metropolis', by Fritz Lang, has influenced various genres since its creation in 1927. With the expressionist representation of a futuristic metropolis, the film producer developed a leitmotif that still inspires artists and designers today.

2015

The idea for the channel grating Metropolis comes from HAURATON France Sales Representative Jean-Christophe Turgné. His aim was, with a functional component such as the drainage channel, to set standards with respect to aesthetics and to impart specific construction projects with futuristic, decorative details.

2016

Designing, planning and building with METROPOLIS - the new design element provides plenty of room for new concepts. Planners and architects can round out trendsetting architecture or lend grown urban structures a decorative element flowing with the most lively ornamentation.

The benefits of **FASERFIX®KS+** channels

NEW

concrete channel
with prefabricated runner
meets the requirements of EN 1433
tests performed by ICI MB in Warsaw
accreditation number AB 115



Numerous grating options

- made of: ductile iron, composite, galvanised or stainless steel
 - three nominal widths: 100, 150 and 200 mm
- = **flexibility**



Ready pre-cast reinforced concrete channel body

- doesn't require preparing a base on the construction site
 - pre-cast concrete channel body made of concrete class C50/60
- = **time and money savings**

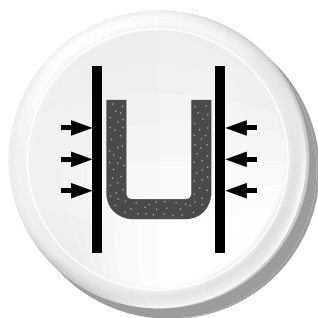

High quality and stability of the material

- loading class E 600
 - average absorbability- 4,8%
 - average weight loss by freezing/unfreezing with a use of salt - 0,02 kg/m²
 - exposure class- XF4, XA3
- = **safety**



Channels in length of 4 m and 1 m

- fast and efficient installation of channels chain because of 4m long channel segments
- significant time savings when a certain tightness is required, thanks to the reduced number of connections

= **cost savings**



Handling elements information



Spherical head anchor
1,3 t



Universal head-link



Mounting method of
a head-link

FASERFIX®KS+ 100

FASERFIX®KS+ 100, channels

type O20, 1 m

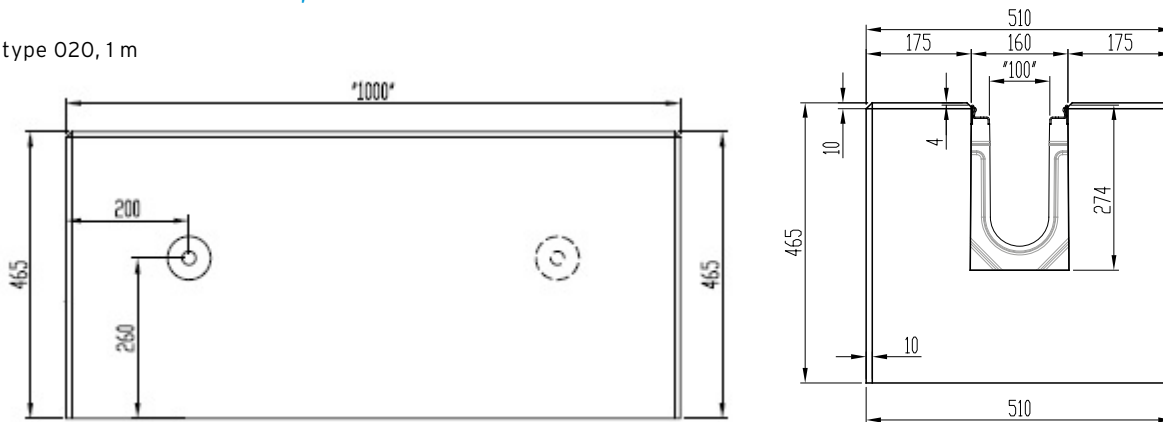

	Lenght mm	Width mm	Height mm	Drainage cross-sect. cm ²	Weight kg	Item No.
type O20	1000	510	465	206	530,0	38101PL
type O20	4000	510	465	206	2120,0	38104PL
type 100F, 1 m	1000	510	230	54	269,00	33101PL
type 100F, 4 m	4000	510	230	54	1076,00	33104PL

Sealing profiles attached to each length on both sides.

Channels with pre-cast concrete channel body are equipped with spherical head anchor 1,3 t (head's diameter - 19 mm, pivot's diameter 10 mm). The product does not include universal head-links.

Channels available also with stainless steel anchor housings, in anthracite and other colors, as well as with different pre-cast concrete channel body surface texturing.

Shallow channels available with protection tubes that enable dowelling with concrete surface.

FASERFIX®KS 100, gratings, class B 125

GUGI mesh grating MW 15/25, black, made of high-quality PA-GF (Polyamide)

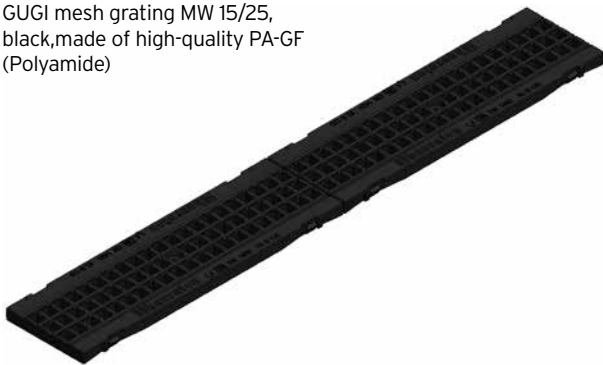

Mesh grating MW 30/10, galvanised

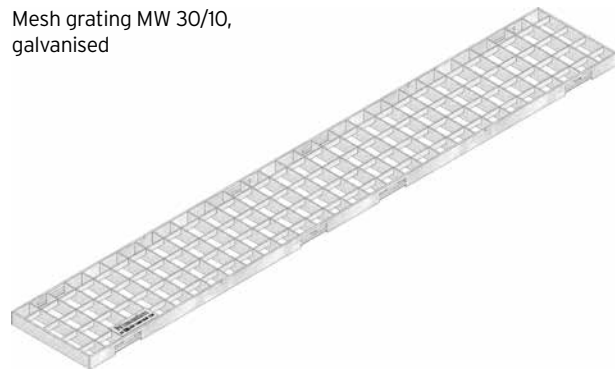

	Lenght mm	Width mm	Height mm	Intake cross-sect. cm ² /m	Weight kg	Item No.
GUGI mesh grating MW 15/25, black, made of high-quality PA-GF (Polyamide)	500	149	20	426	0,9	8099
Mesh grating MW 30/10, galvanised	1000	149	20	716	4,0	8151
Mesh grating MW 30/10, galvanised.	500	149	20	716	2,0	8152
Mesh grating MW 30/30, galvanised	1000	149	20	878	3,0	8077
Mesh grating MW 30/30, galvanised	500	149	20	869	1,5	8078

FASERFIX®KS+ 100, gratings, class C 250

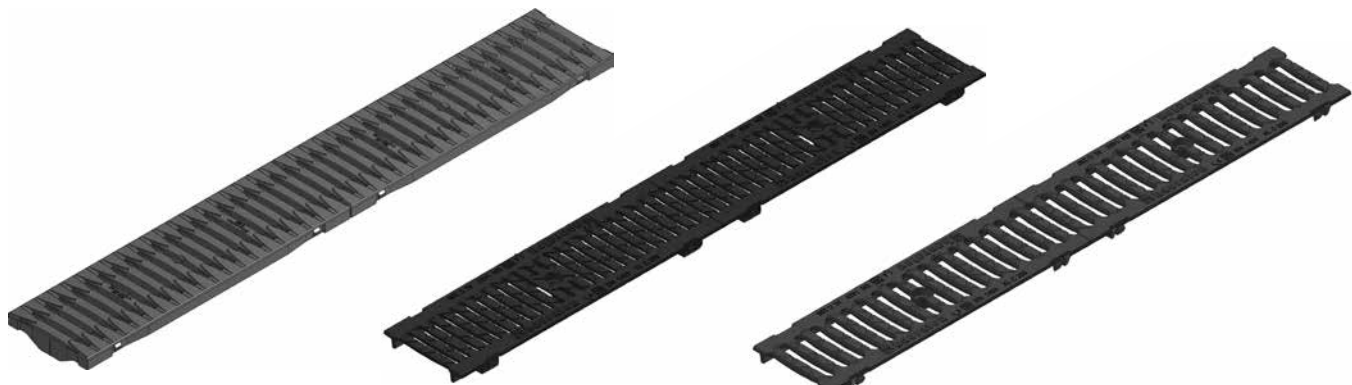

FIBRETEC design slotted grating in the colour Black, SW 9 mm

Ductile iron grating, SW 6, black

Ductile iron grating, SW 6, black

	Lenght mm	Width mm	Height mm	Intake cross-sect. cm ² /m	Weight kg	Item No.
FIBRETEC design slotted grating in the colour Black, SW 9 mm	500	149	20	372	1,05	8098
FIBRETEC design slotted grating in the colour Sand SW 9 mm	500	149	20	372	1,05	8100
FIBRETEC design slotted grating in the colour Fern SW 9 mm	500	149	20	372	1,05	8102
FIBRETEC design slotted grating in the colour Stone SW 9 mm	500	149	20	372	1,05	8101
Ductile iron grating SW 14, black	500	149	20	454	3,30	28064
Ductile iron grating, SW 14 mm, KTL coated	500	149	20	454	3,30	8864
Ductile iron grating SW 6, black	500	149	20	280	3,60	28068
Ductile iron grating, SW 6 mm, KTL coated	500	149	20	280	3,60	8868
Mesh grating MW 30/10, galvanised	1000	149	20	716	5,00	8154
Mesh grating MW 30/10, galvanised	500	149	20	716	2,60	8155
Mesh grating MW 30/10, stainless steel	1000	149	20	776	5,20	28577
Mesh grating MW 30/10, stainless steel	500	149	20	766	2,60	28578
Mesh grating MW 30/30, galvanised	1000	149	20	828	4,40	28073
Mesh grating MW 30/30, galvanised	500	149	20	819	2,20	28074
Reinforced slott grating, SW 10, galvanised	500	149	20	281	2,60	28168
Reinforced slotted grating SW 10, stainless steel	1000	149	20	281	5,10	28169
Reinforced slotted grating SW 10, stainless steel	500	149	20	281	2,53	28170
Mesh grating, MW 30/30, stainless steel	1000	149	20	828	4,90	8573
Mesh grating, MW 30/30, stainless steel	500	149	20	819	2,50	8574
Reinforced slotted grating SW 10, galvanised	1000	149	20	281	5,28	28167
Longitudinal ductile iron grating, bar distance 9 mm, galvanised	500	149	20	528	3,65	8876
Longitudinal ductile iron grating, bar distance 9 mm, KTL coated	500	149	20	528	3,65	8875
Perforated grating diam. 6, galvanised	1000	149	20	99	5,30	28171
Perforated grating diam. 6, galvanised	500	149	20	99	2,60	28172
Perforated grating diam. 6, stainless steel,	1000	149	20	99	5,50	28177
Perforated grating diam. 6, stainless steel	500	149	20	99	2,80	28178

The quality of stainless steel material corresponds to CNS 1.4301 or CNS 1.4307.

FASERFIX®KS+ 100

FASERFIX®KS+ 100, gratings, class D 400*

Ductile iron longitudinal grating,
KTL

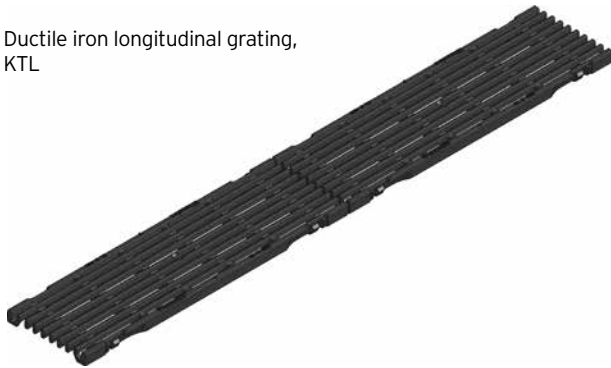

Ductile iron grating, METROPOLIS, black,
KTL

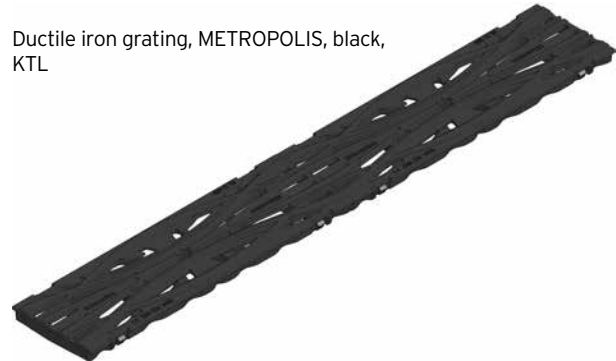

	Lenght mm	Width mm	Height mm	Intake cross-sect. cm ² /m	Weight kg	Item No.
Ductile iron grating, SW 14, black	500	149	20	454	3,6	28063
Ductile iron grating, SW 14, black, KTL	500	149	20	454	3,7	8863
Ductile iron longitudinal grating, KTL	500	149	20	528	4,2	8869
Ductile iron longitudinal grating, galvanised	500	149	20	528	4,2	8870
Ductile iron grating, METROPOLIS, black, KTL	500	149	20	165	5,1	8871

* Not for use across the carriageway of highways or motorways in moving traffic.
For those areas we recommend FASERFIX®TRAFFIC.

FASERFIX®KS+ 100, gratings, class E 600

GUGI-Ductile iron
mesh grating
MW 15/25, black

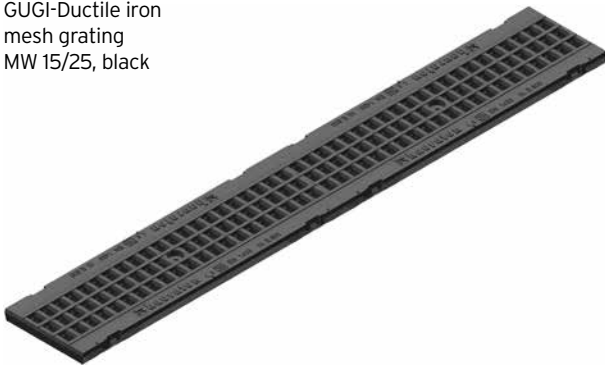

Mesh grating MW 11/30,
galvanised

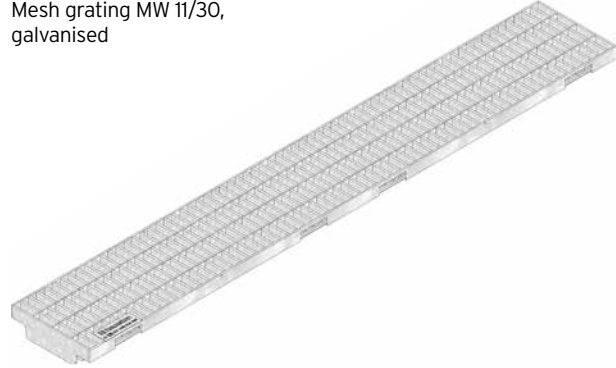

	Lenght mm	Width mm	Height mm	Intake cross-sect. cm ² /m	Weight kg	Item No.
GUGI-Ductile iron mesh grating MW 15/25, black	500	149	20	426	4,0	28079
GUGI-Ductile iron mesh grating, MW 15/25, KTL	500	149	20	426	4,3	8879
GUGI-ductile iron mesh grating MW 15/25, galvanised	500	149	20	426	4,2	28080
Ductile iron grating SW 14, black	500	149	20	454	4,0	28062
Ductile iron grating, SW 14, KTL	500	149	20	454	4,2	8862
Ductile iron grating, SW 6mm, black	500	149	20	280	4,1	28066
Ductile iron grating, SW 6 mm, KTL	500	149	20	280	4,0	8866
Mesh grating MW 11/30, galvanised	1000	149	20	695	11,4	28071
Mesh grating MW 11/30, galvanised	500	149	20	695	4,0	28072
Mesh grating MW 11/30, stainless steel	1000	149	20	695	7,0	28571
Mesh grating MW 11/30, stainless steel	500	149	20	695	4,0	28572
Solid ductile iron cover, black	500	149	20	-	4,5	8262
Solid ductile iron cover, KTL	500	149	20	-	4,7	8962

The quality of stainless steel material corresponds to CNS 1.4301 or CNS 1.4307.

FASERFIX®KS+ 100

FASERFIX®KS+ 100, accessories

Trash box with galvanised mud bucket
view from the front 1

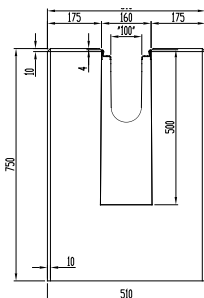

Trash box with galvanised mud bucket
view from the front 2

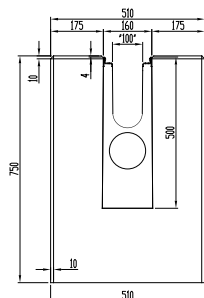

Trash box with galvanised mud bucket
view from the side

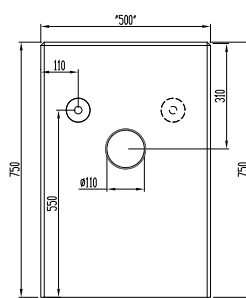

Mud bucket vertical
DN 100, black



End cap with horizontal
UPVC-outlet DN 100,
Type O20



	Lenght mm	Width mm	Height mm	Weight kg	Item No.	Item No. stainless steel
Trash box, with galvanised mud bucket	500	510	750	440,0	38105PL	-
Fouge forming profile for channels*	5	490	420	0,05	38107P	-
Foul air trap, horizontal, with rubber sealing, black	-	-	-	0,1	966	-
Foul air trap DN 100 with hole	-	-	-	0,2	964	-
PVC mud bucket for trash box, 50 cm	420	85	152	0,2	940	-
Mud bucket vertical DN 100, black	100	100	85	-	40293	-
Foul air trap DN 100, outside	-	-	100	0,4	961	-
UPVC-outlet DN 100	-	-	-	0,2	903	-
End cap closed, Type O20	-	160	274	0,6	8083	8183
End cap with horizontal UPVC-outlet DN 100, Type O20	-	160	274	0,7	8089	8187
End cap closed, type 100F	-	160	100	0,20	1183	1683
Cutting to any length	-	-	-	-	891P	-
Mitre cuts NW 100 (price per cut, two cuts necessary)	-	-	-	-	892P	-
Drilling of connecting holes	-	-	-	-	893P	-
Inserting of PVC union connectors	-	-	-	-	894P	-
Locking handle for SUPER KS 100 ductile iron grating	-	-	-	0,1	98210	-
Locking handle for FIBRETEC®100 gratings	-	-	-	0,1	47090	-
Locking handle for stainless steel gratings, without bolt	-	-	-	0,1	47099	-
Hexagonal cap bolt V2A DIN933 M 8 X 35	-	-	-	0,1	99952	-
Universal head-link	-	-	-	-	RD00	-

* Fouge forming profiles are added by default. It is possible to order them additionally separate.
The quality of stainless steel material corresponds to CNS 1.4301 or CNS 1.4307.

FASERFIX®KS+ 150

FASERFIX®KS+ 150, channels

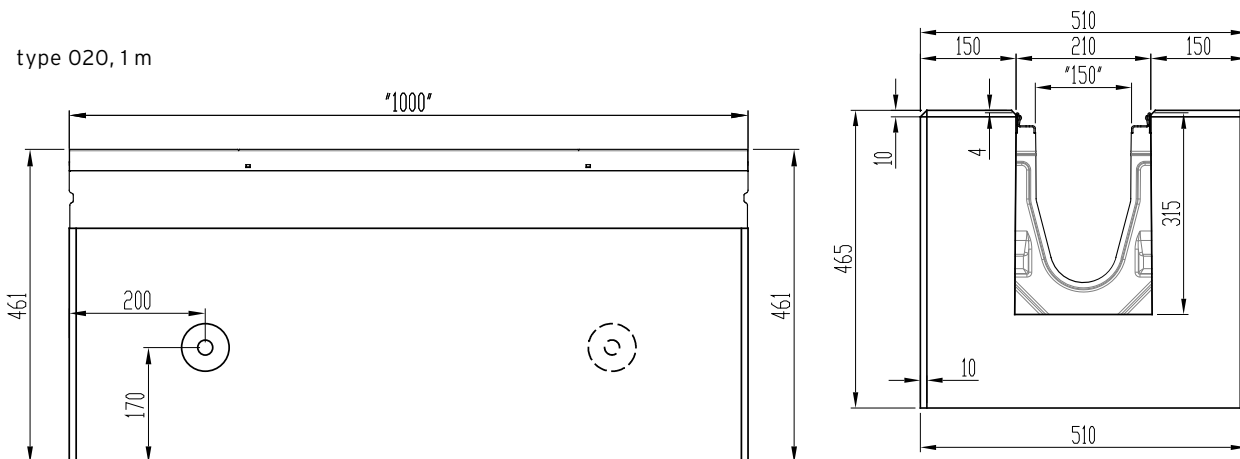

	Length mm	Width mm	Height mm	Drainage cross-sect. cm ²	Weight kg	Item No.
type O20	1000	510	465	312	495,0	31101PL
type O20	4000	510	465	312	1980,0	31104PL
type 110F, 1 m	1000	510	230	74	262,00	34101PL
type 110F, 4 m	4000	510	230	74	1048,00	34104PL

Sealing profiles attached to each length on both sides.

Channels with pre-cast concrete channel body are equipped with spherical head anchor 1,3 t (head's diameter - 19 mm, pivot's diameter 10 mm). The product does not include universal head-links.

Channels available also with stainless steel anchor housings, in anthracite and other colors, as well as with different pre-cast concrete channel body surface texturing patterns.

Shallow channels available with protection tubes that enable dowelling with concrete surface.

FASERFIX®KS+ 150, gratings, class B 125

FIBRETEC Slotted grating,
SW 9 mm, black

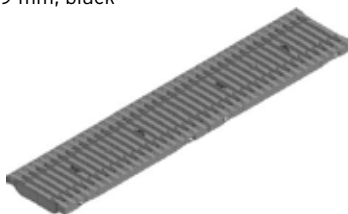

	Length mm	Width mm	Height mm	Intake cross-sect. cm ² /m	Weight kg	Item No.
FIBRETEC Slotted grating, SW 9 mm, black	500	200	20	500	2,0	47170

FASERFIX®KS+ 150

FASERFIX®KS+ 150, gratings, class C 250

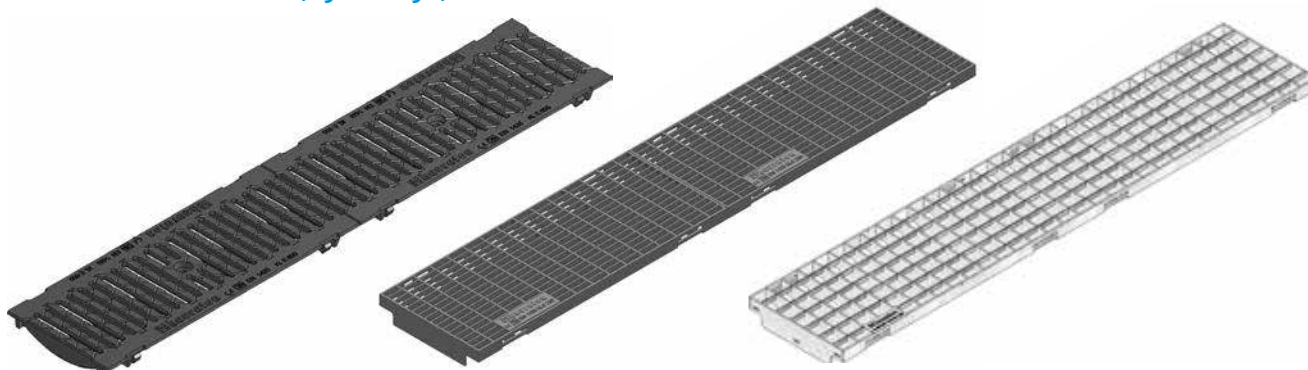

Ductile iron grating
SW 20, black

Mesh grating MW 30/10,
galvanised

Mesh grating MW 30/30,
galvanised

	Lenght mm	Width mm	Height mm	Intake cross-sect. cm ² /m	Weight kg	Item No.
Ductile iron grating SW 20, black	500	199	20	631	5,0	11064
Ductile iron grating, SW 20, KTL	500	199	20	631	5,3	11264
Mesh grating MW 30/10, galvanised	1000	199	20	1105	7,2	11075
Mesh grating MW 30/10, galvanised	500	199	20	1105	3,7	11076
Mesh grating MW 30/10, stainless steel	1000	199	20	1105	8,0	11575
Mesh grating MW 30/10, stainless steel	500	199	20	1105	4,0	11576
Mesh grating MW 30/30, galvanised	1000	199	20	1240	5,9	11073
Mesh grating MW 30/30, galvanised	500	199	20	1240	3,4	11074

The quality of stainless steel material corresponds to CNS 1.4301or CNS 1.4307.

FASERFIX®KS+ 150, gratings, class D 400

Ductile iron grating SW 18, black



Londitudinal ductile iron
grating, galvanised



	Lenght mm	Width mm	Height mm	Intake cross-sect. cm ² /m	Weight kg	Item No.
Ductile iron grating SW 18, black	500	199	20	629	5,3	11463
Ductile iron grating, SW 18, KTL	500	199	20	629	5,3	11563
Londitudinal ductile iron grating, KTL	500	199	20	740	6,9	11269
Londitudinal ductile iron grating, galvanised	500	199	20	740	6,9	11369

* Not for use across the carriageway of highways or motorways in moving traffic.
For those areas we recommend FASERFIX®TRAFFIC.

FASERFIX®KS+ 150

FASERFIX®KS+ 150, gratings, class E 600

GUGI-Ductile iron mesh grating, MW 15/25, black

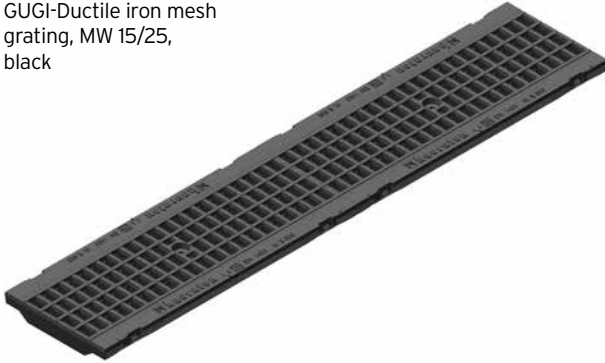

	Lenght mm	Width mm	Height mm	Intake cross-sect. cm ² /m	Weight kg	Item No.
GUGI-Ductile iron mesh grating MW 15/25, black	500	199	20	716	8,4	11068
GUGI-Ductile iron mesh grating, MW 15/25, KTL	500	199	20	716	8,4	11268
Ductile iron grating SW 9, black	500	199	20	557	6,7	11066
Ductile iron grating, SW 9, KTL	500	199	20	557	6,7	11266
Mesh grating MW 11/30, galvanised	1000	199	20	981	18,8	11071
Mesh grating MW 11/30 , galvanised	500	199	20	981	9,4	11072
Mesh grating MW 11/30, stainless steel.	1000	199	20	981	21,0	11571
Mesh grating MW 11/30, stainless steel	500	199	20	981	11,0	11572
Solid ductile iron cover, black	500	199	20	-	6,9	11362

The quality of stainless steel material corresponds to CNS 1.4301 or CNS 1.4307.

FASERFIX[®]KS+ 150

FASERFIX[®]KS+ 150, accessories

Trash box with galvanised mud bucket
view from the front 1

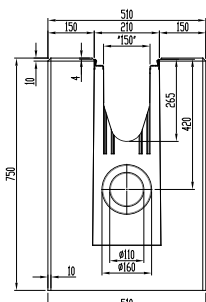

Trash box with galvanised mud bucket
view from the front 2

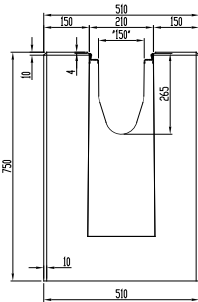

Trash box with galvanised mud bucket
view from the side

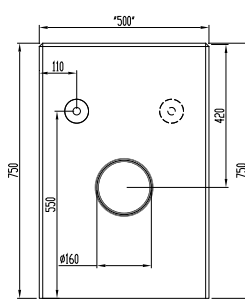

Mud bucket DN 150

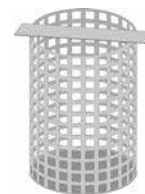

End cap with horizontal UPVC - outlet DN 150, type O20



	Lenght mm	Width mm	Height mm	Weight kg	Item No.	Item No. stainless steel
Trash box, with galvanised mud bucket	500	510	750	420,0	31105PL	-
Fouge forming profile for channels*	5	490	430	0,05	31107P	-
Foul air trap DN 150	584	210	439	2,0	960	-
PVC - connection DN 150	-	-	-	0,5	906	-
Mud bucket DN 150	-	-	180	0,6	2191	-
End cap closed, type O20	-	210	315	1,0	11083	11583
End cap with horizontal UPVC - outlet DN 150, type O20	-	210	315	1,1	11088	11588
End cap closed, type 110F	-	210	110	0,4	2181	2681
Cutting to any length	-	-	-	-	891P	-
Mitre cuts (price per cut, two cuts necessary)	-	-	-	-	892P	-
Drilling of connection holes	-	-	-	-	893P	-
Inserting of PVC union connectors	-	-	-	-	894P	-
Locking handle for all ductile iron gratings	-	-	-	0,1	98260	-
Locking handle for mesh gratings, galvanised	-	-	-	0,1	98265	-
Locking handle for mesh gratings, stainless steel, without bolt	-	-	-	0,1	98255	-
Hexagonal bolt M 10X45, stainless steel, DIN 933 for mesh gratings	-	-	-	0,1	-	91606
Universal head-link	-	-	-	-	RD00	-

* Fouge forming profiles are integral part of a product. There is a possibility to order them separately. The quality of stainless steel material corresponds to CNS 1.4301 or CNS 1.4307.

FASERFIX®KS+ 200

FASERFIX®KS+ 200, channels

typ 010, 1 m

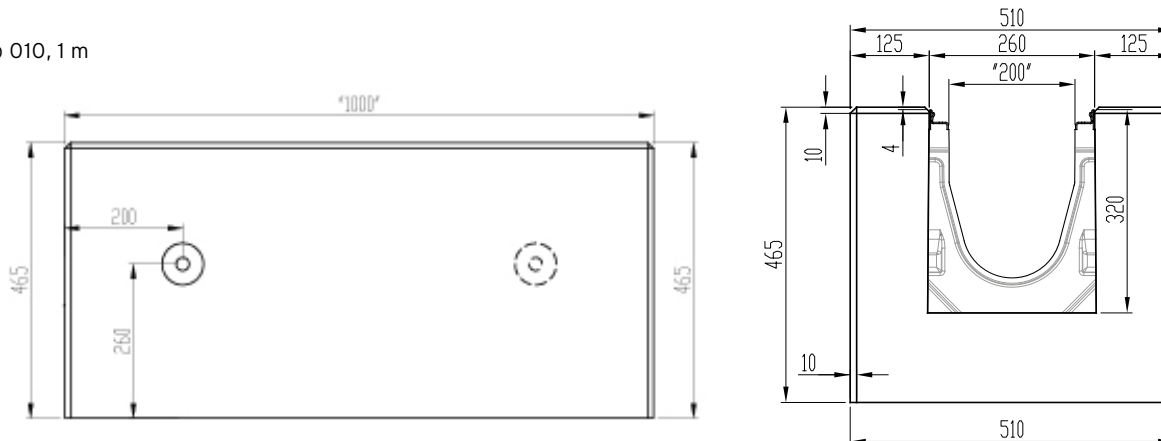

	Length mm	Width mm	Height mm	Drainage cross-sect. cm ²	Weight kg	Item No.
type 010	1000	510	465	409	472,5	32101PL
type 010	4000	510	465	409	1890,0	32104PL
type 110F, 1 m	1000	510	230	89	252,00	35101PL
type 110F, 4 m	4000	510	230	89	1008,00	35104PL

Sealing profiles attached to each length on both sides.

Channels with pre-cast reinforced concrete channel body are equipped with spherical head anchor 1,3 t (head's diameter - 19 mm, pivot's diameter 10 mm).

The product does not include universal head-links.

Channels available also with stainless steel anchor housings, in anthracite and other colors, as well as with different pre-cast reinforced concrete channel body surface texturing.

Shallow channels available with protection tubes that enable dowelling with concrete surface.

FASERFIX®KS+ 200, gratings, class B 125

FIBRETEC slotted
grating, SW 9
mm, black

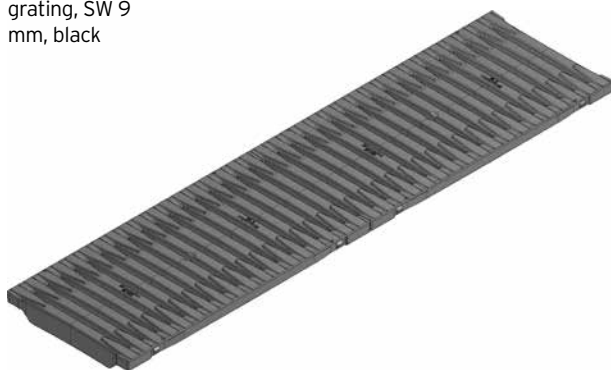

	Length mm	Width mm	Height mm	Intake cross-sect. cm ² /m	Weight kg	Item No.
FIBRETEC slotted grating, SW 9 mm, black	500	249	20	656	2,1	12098

FASERFIX®KS+ 200

FASERFIX®KS+ 200, gratings, class C 250

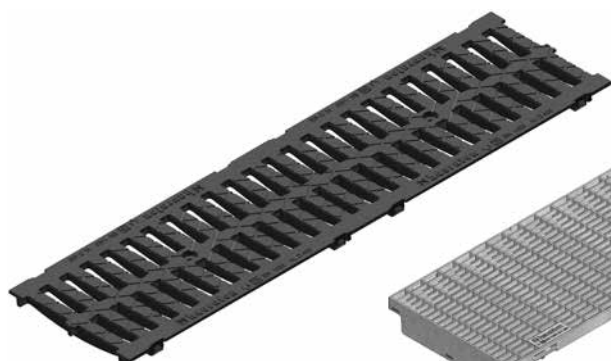

Ductile iron grating SW 20, black

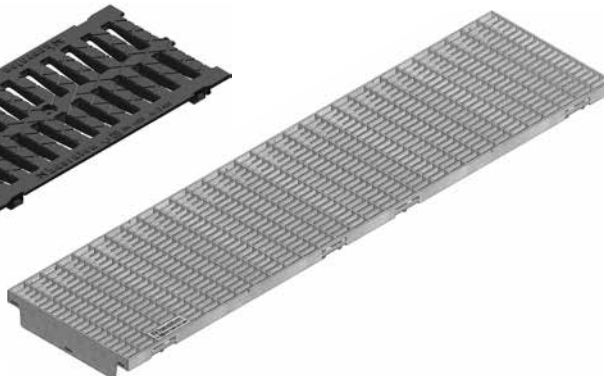

Mesh grating MW 30/10, galvanised

	Lenght mm	Width mm	Height mm	Intake cross-sect. cm ² /m	Weight kg	Item No.
Ductile iron grating SW 20, black	500	249	20	823	5,6	12064
Ductile iron grating SW 20, black, KTL	500	249	20	823	5,8	12264
Mesh grating MW 30/10, galvanised	1000	249	20	1500	10,8	12075
Mesh grating MW 30/10, galvanised	500	249	20	1500	5,5	12076
Mesh grating MW 30/30, stainless steel	1000	249	20	1500	11,0	12575
Mesh grating MW 30/30, stainless steel	500	249	20	1500	5,8	12576
Mesh grating MW 30/30, galvanised	1000	249	20	1681	9,2	12073
Mesh grating MW 30/30, galvanised	500	249	20	1681	4,6	12074
Mesh grating MW 30/30, stainless steel	1000	249	20	1681	9,80	12573
Mesh grating MW 30/30, stainless steel	500	249	20	1681	5,00	12574

The quality of stainless steel material corresponds to CNS 1.4301 or CNS 1.4307.

FASERFIX®KS+ 200

FASERFIX®KS+ 200, gratings, class D 400*

G-TEC Ductile iron grating, SW 9, KTL

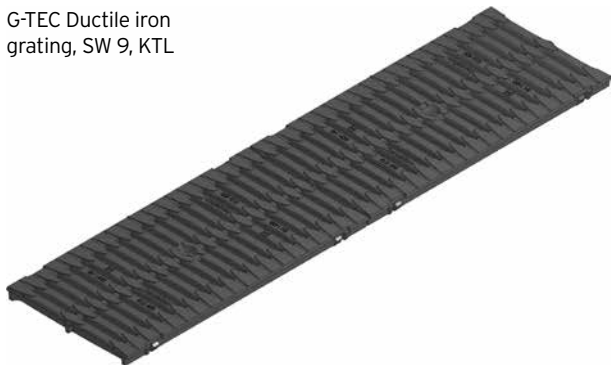

Ductile iron grating as tactile indicator for the visually impaired, black, KTL-coated

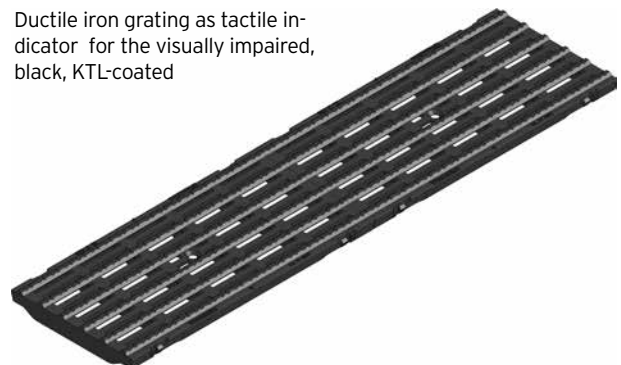

	Lenght mm	Width mm	Height mm	Intake cross-sect. cm ² /m	Weight kg	Item No.
G-TEC Ductile iron grating, SW 9, KTL	500	249	20	595	8,3	12266
Ductile iron grating SW , black	500	249	20	823	6,9	12463
Ductile iron grating, SW 20, KTL	500	249	20	823	7,6	12263
Ductile iron longitudinal grating, KTL	500	249	20	951	9,5	12269
Ductile iron longitudinal grating, galvanised	500	249	20	951	9,5	12369
Ductile iron grating, METROPOLIS, black, KTL	500	249	20	279	10,7	12275
Ductile iron grating as tactile indicator for the visually impaired, black, KTL-coated	500	249	20	606	10,1	12271
Ductile iron grating as tactile indicator for the visually impaired, galvanized	500	249	20	606	10,1	12371

* Not for use across the carriageway of highways or motorways in moving traffic.
For those areas we recommend FASERFIX®TRAFFIC.

FASERFIX®KS 200, gratings, class E 600

Solid ductile iron cover, black

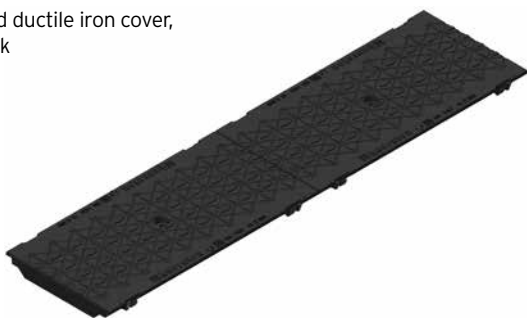

	Lenght mm	Width mm	Height mm	Intake cross-sect. cm ² /m	Weight kg	Item No.
GUGI-Ductile mesh grating MW 15/25, black	500	249	20	886	9,6	12068
GUGI-Ductile iron mesh grating, MW 15/25, KTL	500	249	20	886	9,7	12268
Mesh grating MW 11/30, galvanised	1000	249	20	1309	28,4	12071
Mesh grating MW 11/30, galvanised	500	249	20	1309	14,6	12072
Mesh grating MW 11/30, stainless steel	1000	249	20	1309	29,7	12571
Mesh grating MW 11/30, stainless steel	500	249	20	1309	14,9	12572
Solid ductile iron cover, black	500	249	20	-	8,3	12362
Solid ductile iron cover, KTL	500	249	20	-	8,7	12270

The quality of stainless steel material corresponds to CNS 1.4301 or CNS 1.4307.

FASERFIX®KS+ 200

FASERFIX®KS 200, accessories

Trash box with galvanised mud bucket
view from the front 1

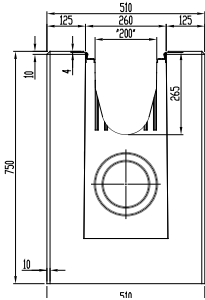

Trash box with galvanised mud bucket
view from the front 2

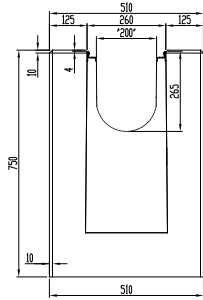

Trash box with galvanised mud bucket
view from the side

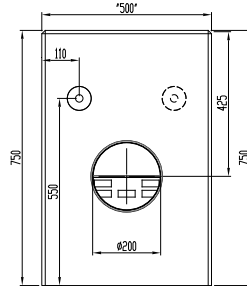

PVC-Connection DN 200



Mud bucket DN 150

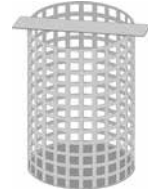

	Lenght mm	Width mm	Height mm	Weight kg	Item No.	Item No. stainless steel
Trash box, with galvanised mud bucket	500	260	600	320,0	32105PL	-
Fouge forming profile for channels*	5	490	420	0,5	32107P	-
PVC-Connection DN 200	-	-	-	0,8	907	-
Mud bucket DN 150	-	-	180	0,6	2191	-
End cap closed, Type 010	-	260	320	1,2	12082	12582
End cap with horizontal UPVC-outlet, DN 150, galvanised, Type 01 - 010	-	260	320	1,5	12087	12587
End cap, closed, type 110 F	-	260	110	0,4	3181	3681
Cutting to any length	-	-	-	-	891P	-
Mitre cuts (price per cut, two cuts necessary)	-	-	-	-	892P	-
Drilling of connection holes	-	-	-	-	893P	-
Inserting of PVC union connectors	-	-	-	-	894P	-
Locking handle for FASERFIX KS 200	-	-	-	0,3	98221	-
Universal head-link	-	-	-	-	RD00	-

The quality of stainless steel material corresponds to CNS 1.4301 or CNS 1.4307.

* Fouge forming profiles are integral part of a product. There is a possibility to order them separately.

FASERFIX®KS+

Reference objects



OLD QUAY SZCZECIN

The general renovation of the Old Quay on the Łasztownia in Szczecin included a fragment from the Castle Route towards the Old Slaughterhouse. The 650 meter long wharf section has turned into a 12-meter boulevard. The city has gained a natural extension of the Gdynia Boulevard reconstructed several years ago. Thanks to this investment, the surroundings of Szczecin's historic harbor cranes became more beautiful.



VISUAL ASPECT OF THE QUAY

In order to preserve the aesthetic image of the renovated boulevard, it was necessary to use drainage that would not only be functional, but also fit into the character of this place. For the needs of this investment HAURATON made a special version of concrete channels with monolithic pre-cast reinforced concrete lowered channel body - FASERFIX®KS+. This type of solution made it possible to arrange the paving stones up to the channels line itself. The overall picture and aesthetics of the wharf have been preserved.



GALERIA PÓŁNOCNA WARSAW

Completed in 2017, Galeria Północna is a modern shopping center in Warsaw. A rich commercial offer is combined here with relaxation in the city space. Elements such as the roof garden, open air gym and skate park, children's playgrounds or squares with fountains and elements of small architecture perfectly fit the building into the green nature of the northern part of Warsaw.

ENVIRONMENTAL FRIENDLY CONCRETE

Gallery North is certified LEED (Leadership in Energy & Environmental Design) awarded to buildings that can save resources and have a positive impact on the health of residents. This is the first building in the capital designed with care for the environment.

For this investment HAURATON provided drainage made of concrete, which is an environmentally friendly material, due to its natural composition, which is drawn from natural resources, and is also fully recyclable. This material is also very durable and long lasting. The FASERFIX®KS + channels with monolithic pre-cast reinforced concrete channel body installed on this object mean not only easy and quick assembly, but also a guarantee of stability for many years.



INSTALLATION INSTRUCTIONS

ASPHALTED AREAS, PAVEMENT, CONCRETE

KI. A 15 - D 400

Installation example
asphalted areas, pavement, concrete class D 400

* - h (channel height plus overhang)
Depending on type of a surface following dilatations should be made:
- asphalt - bituminous joint strip between surface and channel,
- pavement - joint between surface and channel,
- concrete - joint at distance of about 1 m from a channel.

Category according to EN 1433 / DIN 19580	A 15	B 125	C 250	D 400**	E 600	F 900
Foundation: with b / thickness d / height h (in cm)	10 / 15 / *	10 / 15 / *	10 / 15 / *	10 / 15 / *		
The named concrete quality is a minimum quality						
EN 206-1 / DIN 1045-1 without danger of frost on the lateral support	C 12/15	C 12/15	C 12/15	C 12/15		
EN 206-1 / DIN 1045-2 with danger of frost on the lateral support	C 12/15	C 12/15	C 12/15	C 12/15		

The installation examples / advice constantly are adapted to the technical conditions. With new editions older expenditures lose their validity. Before planning or installation please verify the current version at www.hauraton.com.

Condition: 01.10.2015

Our general installation instructions apply.

Applying to following systems:
FASEFIX KS 100, KS 150, KS 200 with integrated, reinforced concrete runner

Format DIN A4
scale 1:15

hauraton
ul. Ostrowska 398
61-312 Poznań
POLSKA
tel.: +48 (061) 66 25 444
fax: +48 (061) 66 25 440
hauraton@hauraton.com.pl

CONCRETE

KI. A 15 - E 600

Przykład zabudowy
nawierzchnia betonowa w kl. E 600

* h (wysokość korytka wraz z podwyższeniem)
** szczelina powinna być zaprojektowana w taki sposób, aby skompensować siły poziome oddziałujące na odwodnienie liniowe na skutek rozszerzalności płyt betonowych

Klasa obciążenia według normy PN EN 1433 / DIN 19580	A 15	B 125	C 250	D 400**	E 600	F 900
Fundament: szerokość b / grubość d / wysokość h (w cm)					10 / 15 / 47	
Podana klasa betonu to klasa minimalna						
EN 206-1 / DIN 1045-1 fundament nie narazony na przemrażanie					C 20/25	
EN 206-1 / DIN 1045-2 fundament narazony na przemrażanie					C 30/37 XD 1	

Obowiązuje dla następujących systemów:
FASEFIX KS+100, KS+150, KS+200 z rusztem żelaznym kl. E600

Format DIN A4
Skala 1:15

hauraton
ul. Ostrowska 398
61-312 Poznań
POLSKA
tel.: +48 (061) 66 25 444
fax: +48 (061) 66 25 440
hauraton@hauraton.com.pl

Stan na dzień: 13.06.2017

Obowiązują ogólne zasady zabudowy

CONCRETE

Kl. A 15 - D 400

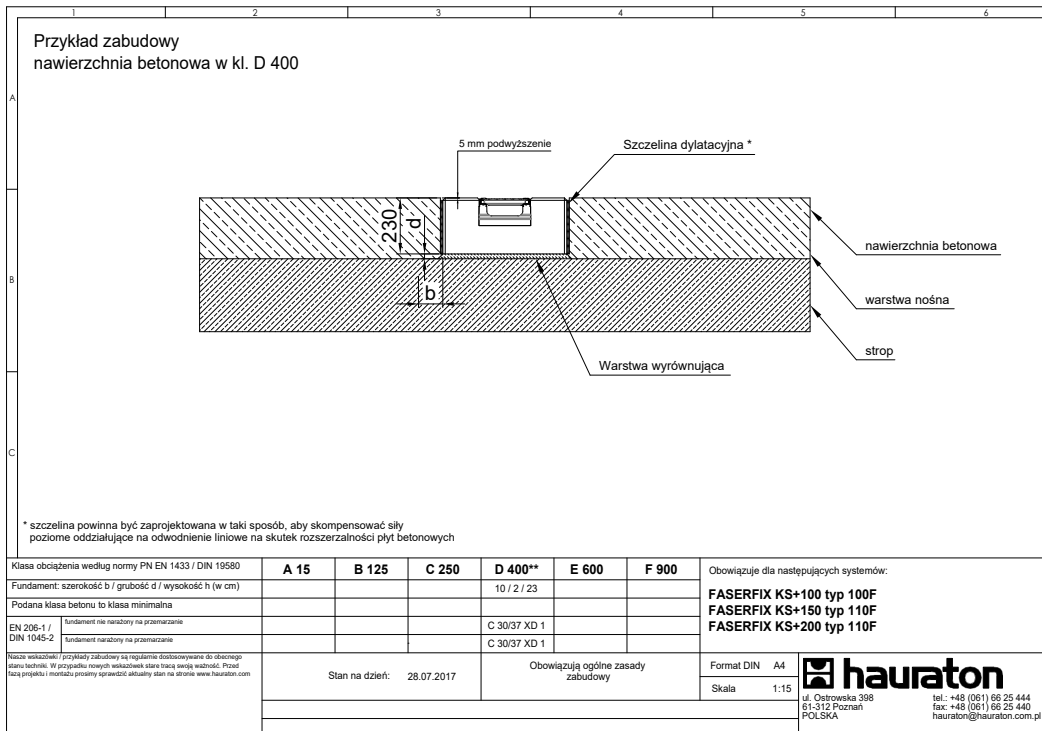

CONCRETE

Kl. A 15 - E 600

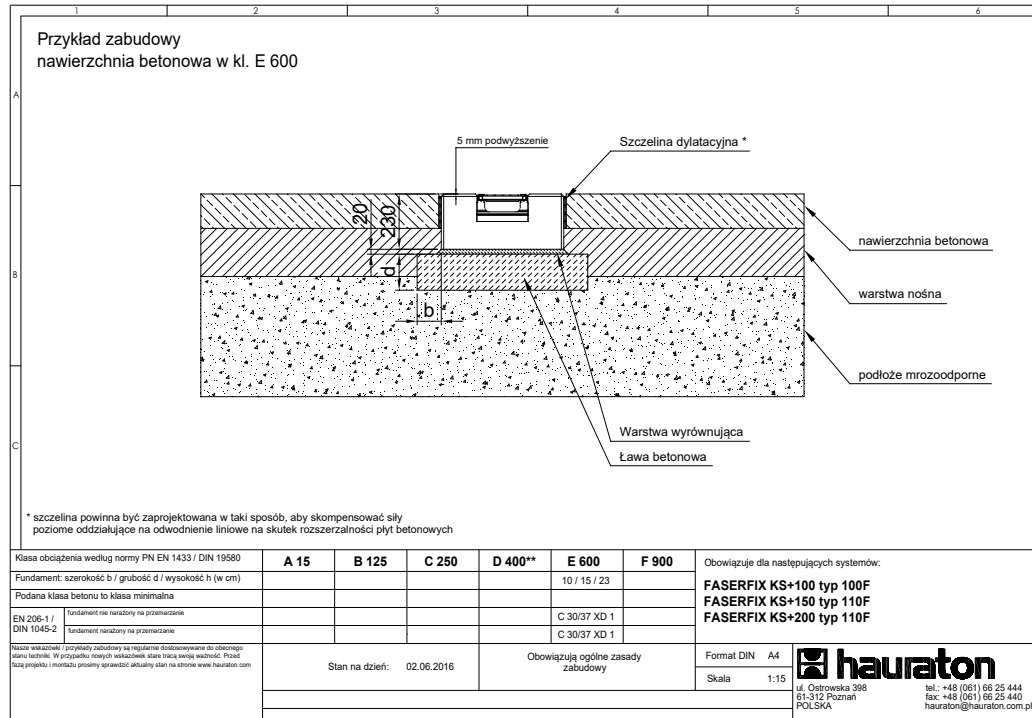

You are welcome to contact our technical department for support and get further information on installation advices:

PATRYCJUSZ SOŁENCZEW

Design and technical engineer

landline: 61/ 66 25 450

mobile: 785 250 351

patrycjusz.solenczew@hauraton.com.pl

MACIEJ PAWLAK

Inżynier ds. Techniczno-Projektowych

tel.: 61/ 66 25 452

tel. kom.: 601 541 626

maciej.pawlak@hauraton.com.pl



HAURATON POLSKA SP. Z O.O.

UL. OSTROWSKA 398

61-312 POZNAŃ

TEL. +48 61 66 25 444

hauraton@hauraton.com.pl

www.hauraton.com.pl

