



 **hauraton**

KERBFIX

Recycled & Recyclable Heavy-Duty
Combined Kerb & Drainage System



KERBFIX

Combined Kerb & Drainage System



What is KERBFIX?

KERBFIX is a heavy-duty combined kerb and drainage system (CKD) that provides efficient and safe draining of highways, car parks, retail and commercial areas, or any structure with a kerb-edge design.

All exposed impermeable surfaces and structures require efficient drainage to prevent flooding or settlement.

The KERBFIX system collects run-off continually and quickly which helps extend the life of a project and improve the conditions for users and their safety.

Unlike traditional kerb and gully method where flows compound on the surface, the collected run-off is contained and driven to an outlet hidden within the channel body.

KERBFIX is a much more efficient method of drainage and levels across site can be simplified to deliver run-off directly to a linear low point.

KERBFIX

Environmental Benefits

Sustainable approach

Ensuring the reduction and offsetting of environmental impacts is essential in project design.

KERBFIX products have a 70 percent recycled plastic content. Opting for products with a high recycled content effectively eliminates the significant risks associated with waste, safeguarding the natural environment.

KERBFIX products and systems are designed to lower risk and minimise impacts throughout their life cycle.

This commitment spans from the initial material sourcing to subsequent stages of reuse, recycling, or carbon recovery, guaranteeing a comprehensive approach to sustainability.

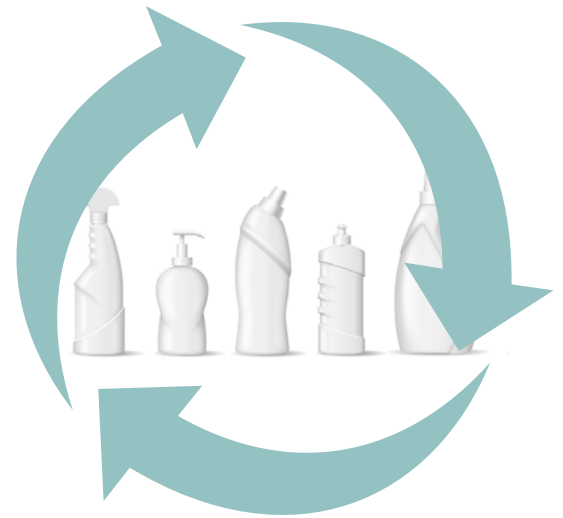

From controlled sourcing, reprocessing to manufacturing processes, each step prioritises energy efficiency, producing products with a reduced carbon footprint. Furthermore, the lightweight properties of each product enhances transport efficiency, minimising carbon impact.

199

RECYCLED PLASTIC BOTTLES, CAPS AND CLOSURES IN EVERY UNIT

KERBFIX

Sustainable Construction

High recycled content

The KERBFIX solution allows the opportunity to design and construct sustainably.

Every 500mm unit of KERBFIX is made from **70 percent recycled material.**

On average, **199 plastic bottles, caps and lids** are used in the manufacturing process.

The system can also be **recycled after lifetime use.**

An improving cycle

With KERBFIX, the increased cost of using recycled material is offset by the innovative and fully automated process of production.

1. Creating solutions using recycled materials creates a demand
2. Demand drives new industry and encourages better collection and control of waste material
3. Improved collection and grading provides greater potential for use
4. Increased use of recycled and recyclable products provides greater potential for recovery
5. Greater potential for recovery reduces the cost of recycling and impact to the environment
6. Reduced cost of recycling encourages increased use



30,676 KG
OF CARBON SAVED

70%
RECYCLED MATERIAL
USED IN EVERY 500MM UNIT

100%
RECYCLABLE AFTER
LIFETIME USE

YOUR BENEFITS WITH **KERBFIX**

HIGH HYDRAULIC PERFORMANCE

large usable volume
smooth inner surface for superior flow characteristics
(roughness value = 0,009)

= PERFORMANCE ASSURED



LOW WEIGHT ENSURES EASY HANDLING ON SITE

significantly lighter than conventional kerb stones
especially easy transport and fast installation
example: KERBFIX 305 half battered - weight 7 kg

= TIME & COST SAVINGS



HIGH-GRADE MATERIAL

especially robust material
recycled and recyclable standard units → environmentally friendly
KERBFIX can be cut, drilled and worked easily on site

= PERFORMANCE ASSURED / QUALITY ASSURED



LOW MAINTENANCE

easy cleaning by rinsing through the inspection box
durable high-quality appearance

= TIME & COST SAVINGS



1

Made with a high recycled content



3

Large inflow openings

2

Stable and lightweight

4

Hydraulically efficient design

IDEAL FOR ...

carriageways, car parks, retail and industrial developments with a kerb-edge design.

KERBFIX

Delivers Hydraulically

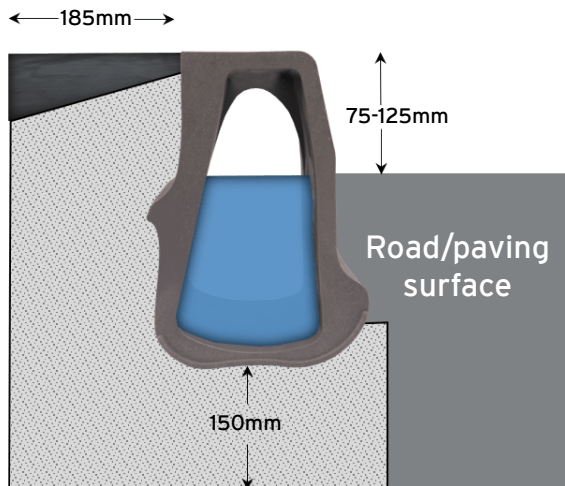

High flow volume

The combination of a large usable volume and hydraulically efficient material means KERBFIX creates fast flows. This means large areas can be drained quickly and safely, protecting surfaces by taking run-off at multiple points across the whole length of the kerb-line. All of this aids in the longevity of the structure, system and product, reducing the frequency for future maintainance.

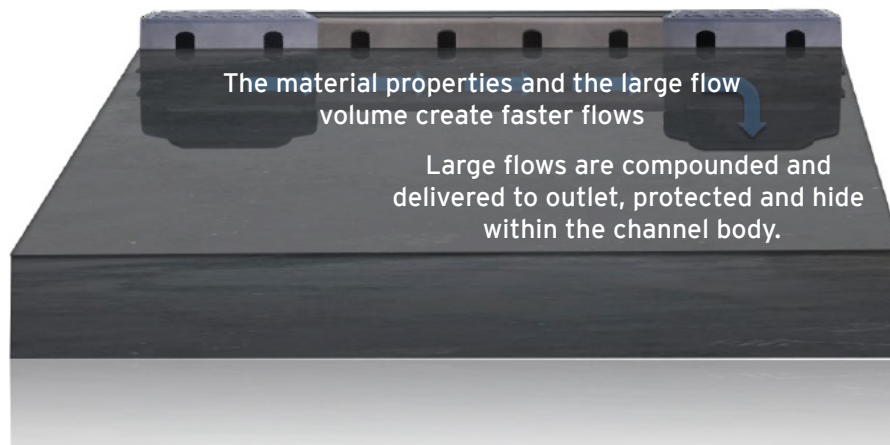

Total integration

The key to the success of any surface drainage system is its installation and integration. A system has to be installed correctly and equally integrated within varied surfaces across a project which can often have different operational challenges. A precise quality finish during installation with sound integration between the product, system, bed, brace/backing and landscape/surfacing will ensure optimum performance and longevity.

KERBFIX has a unique retention element that ensures all units are fixed and fully integrated with the brace/haunch during installation. Each section of CKD is bound by solid iron access and gully outfalls to give you a truly heavy-duty and robust combined kerb and surface drainage system.

KERBFIX

Safety Benefits

KERBFIX combined kerb and drainage system is manufactured from a recycled polypropylene (PP).

The recycled plastics used in the manufacturing processes produce lightweight units. They are rated for use in heavy traffic areas such as highway and are far easier to work and handle than conventional concrete drainage kerbs.

KERBFIX dramatically reduces the time and resources needed to complete the kerb drain installation.



Unlike concrete kerb drainage systems, KERBFIX contains no carcinogenic silica and is designed to be cut using a hand saw eliminating the risk of exposure to RCS (respirable crystalline silica) a known cause of cancer.

The lightweight standard units mean a simple, quicker and easier method of installation reducing your impact on the environment and your workforce.

Kerbs and paving material are common construction products. Regularly lifting, carrying or handling them can present significant risks of developing musculoskeletal problems.

Think about limiting the risks before work starts by avoiding the need for heavy products altogether. Use the lightest product that fulfills the design criteria.



Less than **8.5kg**

KERBFIX is designed to be manually installed in line with HSE guidelines.

REFERENCES

Areas of Applications



Histon Road Cambridge



REFERENCES

Areas of Applications



Symphony Kitchens Distribution Centre



Starbucks Trafford Retail Park



Costa Coffee Rotherham Retail Park

KERBFIX

System Structure

At a Glance

- ✓ Safety due to high compressive & flexural strength to withstand both load & impact
- ✓ Increased productivity due to recycled lightweight standard units
- ✓ Loading capacity up to class D 400 according to EN 1433

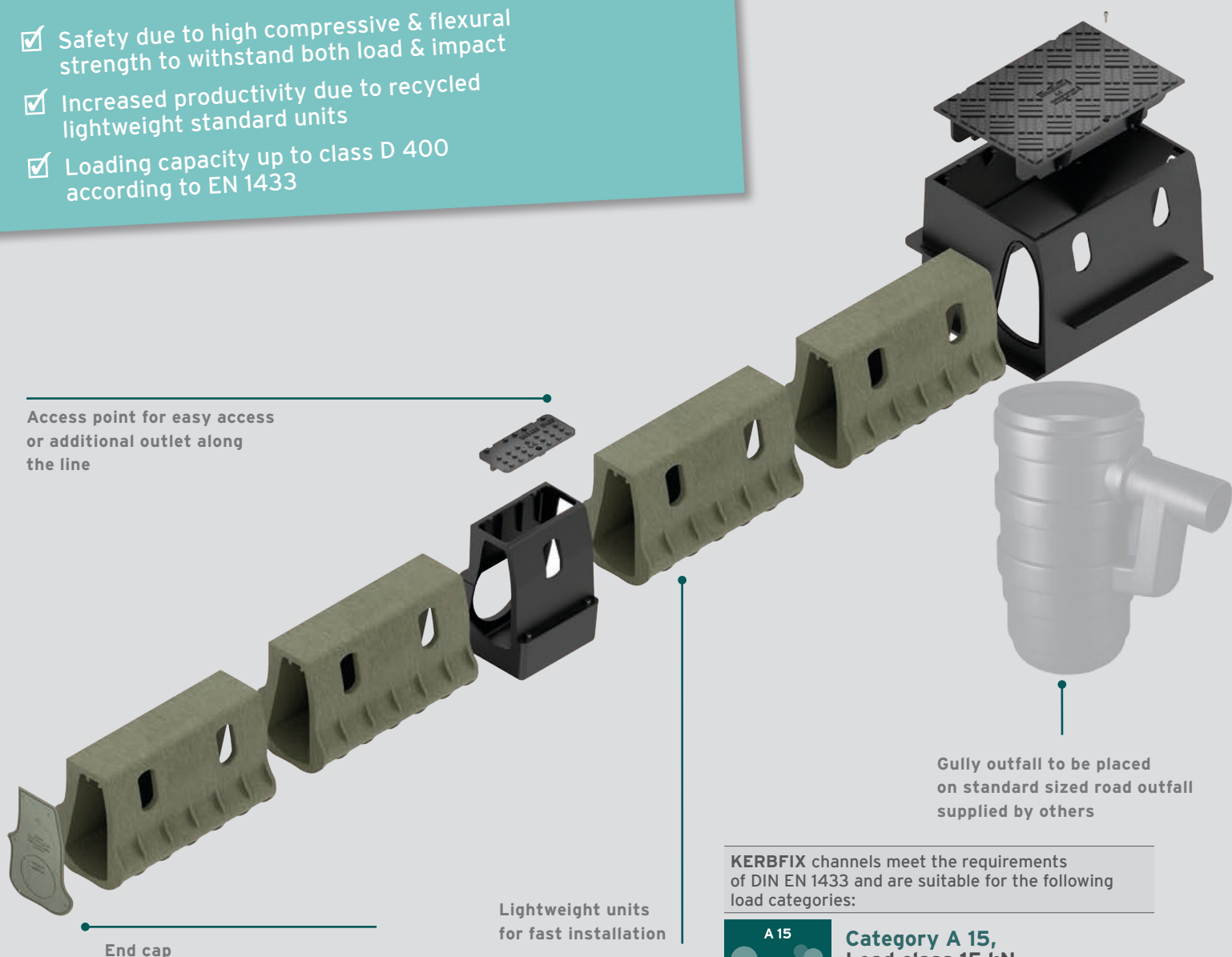

KERBFIX channels meet the requirements of DIN EN 1433 and are suitable for the following load categories:



A 15

**Category A 15,
Load class 15 kN**

Traffic areas without car access



B 125

**Category B 125,
Load class 125 kN**

Traffic areas on private premises



C 250

**Category C 250,
Load class 250 kN**

Public areas with light traffic and moderate frequency



D 400

**Category D 400,
Load class 400 kN**

Roadways and streets (not for installation in the carriageway in motorways)

KERBFIX

Quality, Compliance and Performance-Assured



Meeting Standards

Combined kerb and linear drainage systems are recognised universally as an efficient method of draining surface water.

KERBFIX is manufactured and complies fully in accordance with EU Harmonised and UK Designated Standards (EN1433 Load Category Group 4-D400) and carries the CE mark.

Group 3 (min, class C 125) - Kerb sides and non-trafficked areas of hard shoulders and similar.

Group 4 (min, class D 400) - Carriageways of roads (including pedestrian streets), hard shoulders and parking areas, for all types of road vehicles.

Please note - Qualification under EN1433 verifies compliance, defining the requirements for a product based on its intended use/function. Additionally, a hydraulic function check for each section of CKD is necessary.

EN1433 also stipulates installation "must" be carried out as per manufacturers installation advice. Please visit our website for more information.

KERBFIX

Half Battered Kerb

Standard Units

Half Battered Standard Unit

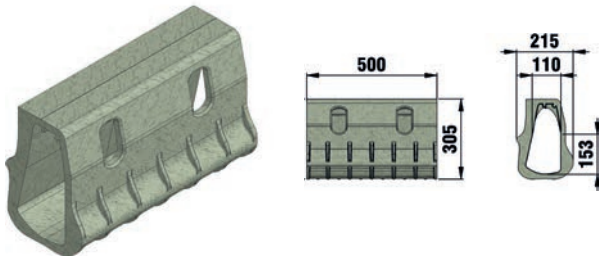

Half Battered Gully Outfall

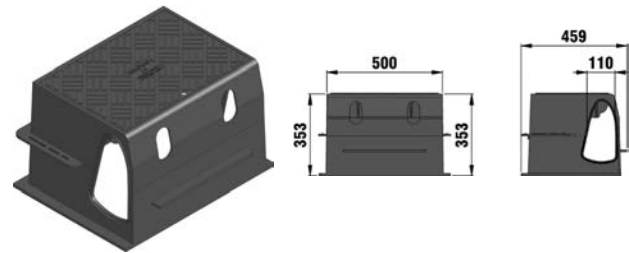

End Cap/Outlet



Half Battered Rodding Access/Outlet Unit

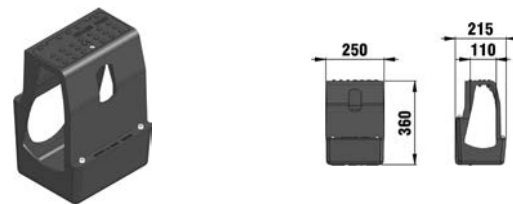

	Length mm	Width mm	Height mm	Internal channel cross-sect. cm ²	Intake cross-sect. cm ² /m	Weight kg	Item No.
Half Battered Standard Unit	500	215	305	212	184	7,00	10185
Half Battered Gully Outfall	500	459	353	-	-	78,00	10186
End Cap/Outlet	-	211	301	-	-	0,20	10187
Half Battered Rodding Access/Outlet Unit	250	215	360	-	-	19,00	10188

KERBFIX

Half Battered Kerb

Drop Kerbs

Left Hand Drop Kerb L305

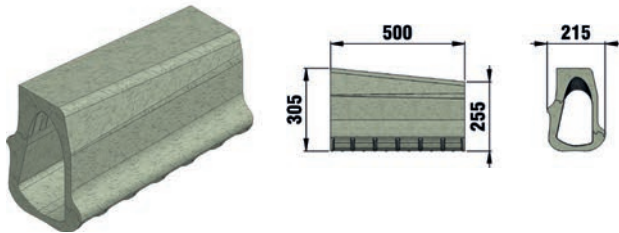

Right Hand Drop Kerb R255

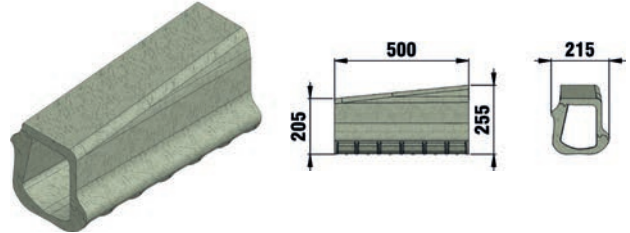

Drainable Centre Stone

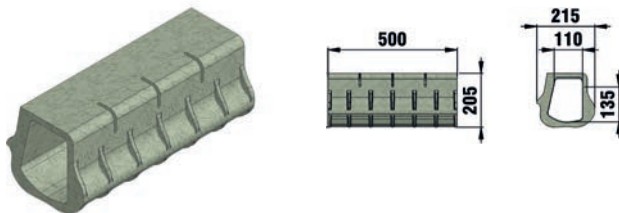

	Length mm	Width mm	Height mm	Internal channel cross-sect. cm ²	Intake cross-sect. cm ² /m	Weight kg	Item No.
Left hand Drop Kerb L305	500	215	305 - 255	224	-	7,00	10189
Left hand Drop Kerb L255	500	215	255 - 205	192	-	5,00	10190
Right Hand Drop Kerb R305	500	215	305 - 255	224	-	7,00	10191
Right Hand Drop Kerb R255	500	215	255 - 205	192	-	5,00	10192
Drainable Centre Stone	500	215	205	192	29	4,80	10193

KERBFIX

Half Battered Kerb

Radius Units

HB External Radius Unit 7/5

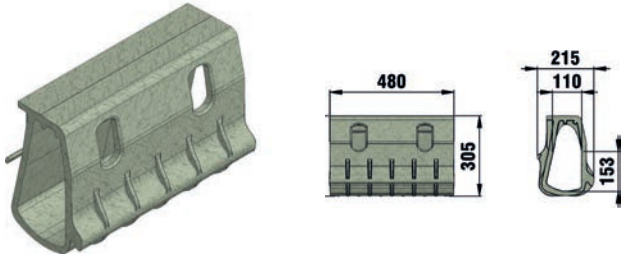

HB External Radius Unit 27/13

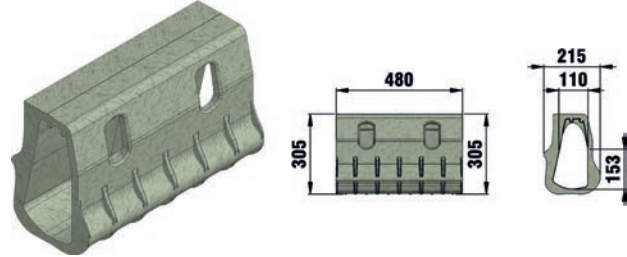

HB Internal Radius Unit 12/8

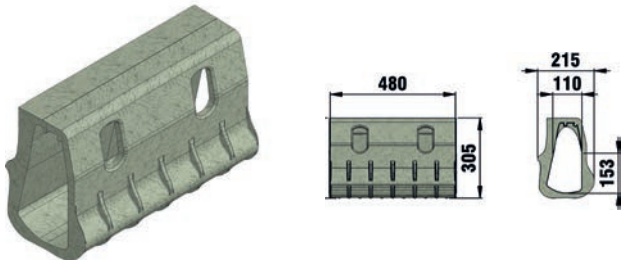

	Length mm	Width mm	Height mm	Internal channel cross-sect. cm ²	Intake cross-sect. cm ² /m	Weight kg	Item No.
HB External Radius Unit 7/5	480	215	305	212	184	7,00	10194
HB External Radius Unit 12/8	480	215	305	212	184	7,00	10195
HB External Radius Unit 27/13	480	215	305	212	184	7,00	10196
HB Internal Radius Unit 7/5	480	215	305	212	184	7,00	10197
HB Internal Radius Unit 12/8	480	215	305	212	184	7,00	10198
HB Internal Radius Unit 27/13	480	215	305	212	184	7,00	10199

KERBFIX

Half Battered Kerb

90° Corners

External HB-90 Degree Corner

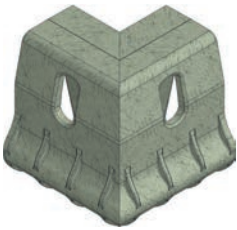

Internal HB-90 Degree Corner



External CS-90 Degree Corner



Internal CS-90 Degree Corner

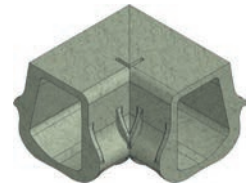

	Length mm	Width mm	Height mm	Internal channel cross-sect. cm ²	Intake cross-sect. cm ² /m	Weight kg	Item No.
External HB-90 Degree Corner	300	215	305	212	153	7,00	10200
Internal HB-90 Degree Corner	300	215	305	212	51	7,00	10201
External CS-90 Degree Corner*	300	215	205	192	26	7,00	10202
Internal CS-90 Degree Corner*	300	215	205	192	9	7,00	10203

*items made upon request

Accessories

	Length mm	Width mm	Height mm	Weight kg	Item No.
One Part Low Modulus Polyurethane Sealant	-	-	-	2,00	10204
Sealant gun					10205

KERBFIX

Full Battered Kerb (Splay)

Standard Units

Full Battered Standard Units

Full Battered Gully Outfall

End Cap/Outlet

Full Battered Rodding Access/Outlet Unit

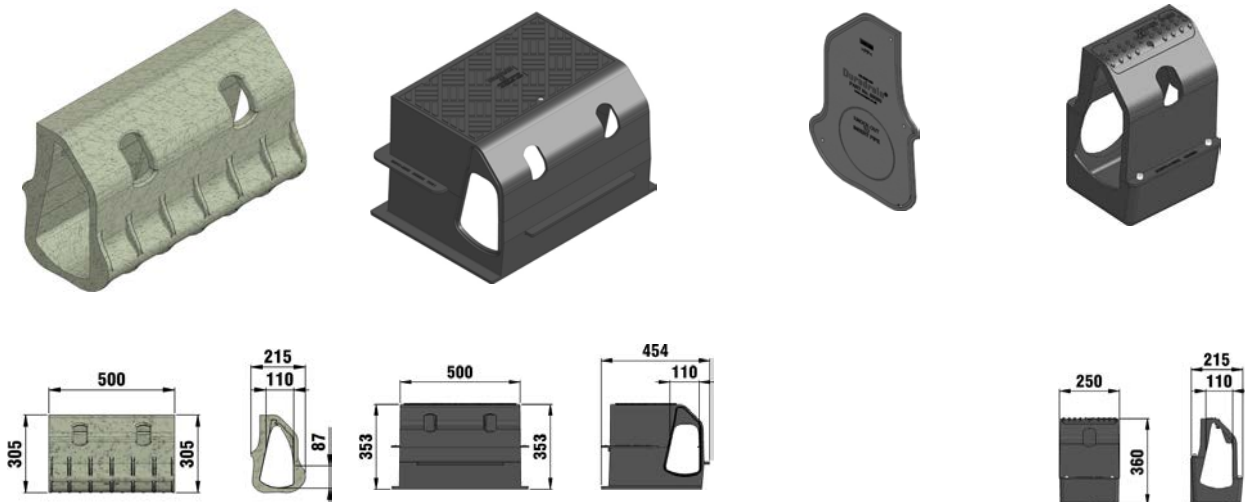

	Length mm	Width mm	Height mm	Internal channel cross-sect. cm ²	Intake cross-sect. cm ² /m	Weight kg	Item No.
Splay Full Battered Standard Unit	500	215	305	221	184	7,00	10549
Splay Full Battered Gully Outfall	500	459	353	-	-	78,00	10550
Splay End Cap/Outlet	-	211	301	-	-	0,20	10551
Splay Full Battered Rodding Access/Outlet Unit	250	215	360	-	-	19,00	10553

KERBFIX

Full Battered Kerb (Splay)

Radius Units

External Radius Unit

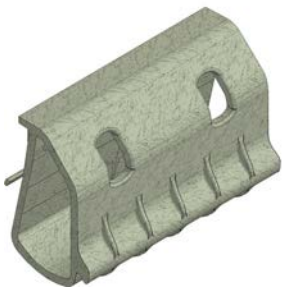

Internal Radius Unit

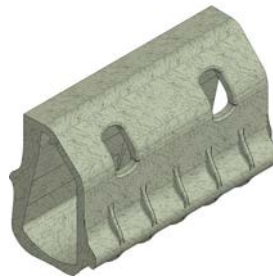

	Length mm	Width mm	Height mm	Internal channel cross-sect. cm ²	Intake cross-sect. cm ² /m	Weight kg	Item No.
Splay External Radius Unit 5/6	480	215	305	221	184	7,00	10556
Splay External Radius Unit 7/10	480	215	305	221	184	7,00	10558
Splay External Radius Unit 11/16	480	215	305	221	184	7,00	10560
Splay Internal Radius Unit 5/6	480	215	305	221	184	7,00	10557
Splay Internal Radius Unit 7/10	480	215	305	221	184	7,00	10559
Splay Internal Radius Unit 11/16	480	215	305	221	184	7,00	10561



KERBFIX products are exclusively supplied by HAURATON.
We are an official stockist of the acclaimed DuraDrain manufactured by
Duraproducts and sold under our brand name KERBFIX.



All drawings, measurements and weights are provided by Duraproducts. We reserve the right to make technical changes for improvement.

HAURATON UK
Unit 4 French's Ave
Dunstable
LU6 1BH

Tel. 01582 501380
Fax. 01582 501399
sales-uk@hauraton.com
www.hauraton.com